

**Electronic voltage monitoring relays for single and three-phase applications**

- Multifunctional types, providing the flexibility of monitoring Undervoltage, Overvoltage, Window Mode, Phase rotation, Phase loss
- Positive safety logic - Make output contact opens if the relay detects an error
- All functions and values can be easily adjusted by the selector and trimmer on front face
- "Blade + cross" – both flat blade and cross head screw drivers can be used to adjust the regulators and the function selector
- Colored LEDs for clear & immediate visual indication
- 1 CO relay output, 6 or 10 A
- Modular housing, 17.5 or 35 mm wide
- 35 mm rail (EN 60715) mount
- Cd-free contact material

Screw terminal



For outline drawing see page 10

**Contact specification**

Contact configuration		1 CO (SPDT)	1 CO (SPDT)
Rated current/Maximum peak current	A	10/30	6/10
Rated voltage/ Max. switching voltage	V AC	250/400	250/400
Rated load AC1	VA	2500	1500
Rated load AC15	VA	750	500
Single phase motor rating (230 V AC)	kW	0.5	0.185
Breaking capacity DC1: 30/110/220 V	A	10/0.3/0.12	6/0.2/0.12
Minimum switching load	mW (V/mA)	300 (5/5)	500 (12/10)
Standard contact material		AgNi	AgNi

**Supply specification**

Nominal system voltage ( $U_N$ )	V AC (50/60 Hz)	220...240	380...415
Rated power	VA (50 Hz)/W	2.6/0.8	11/0.9
Operating range	V AC (50/60 Hz)	130...280	220...510

**Technical data**

Electrical life at rated load AC1	cycles	$80 \cdot 10^3$	$60 \cdot 10^3$
Voltage detection level range	V	170...270	300...480
Asymmetry detection level range	%	—	—
Switch-off delay time (T on function diagrams)	s	0.5...60	0.5...60
Switch-on lock-out time	s	0.5	1
Switch-on hysteresis (H on function diagrams)	V	5 (L-N)	10 (L-L)
Power-on activation time	s	$\approx 1$	$\approx 1$
Insulation between supply and contacts (1.2/50 $\mu$ s)	kV	4	4
Dielectric strength between open contacts	V AC	1000	1000
Ambient temperature	$^{\circ}$ C	-20...+60	-20...+60
Protection category		IP 20	IP 20

**Approvals** (according to type)



**70.11**



Single-phase (220...240)V voltage monitoring:

- Undervoltage
- Overvoltage
- Window mode (overvoltage + undervoltage)
- Voltage fault memory selectable

**70.31**



Three-phase (380...415)V voltage monitoring:

- Undervoltage
- Overvoltage
- Window mode (overvoltage + undervoltage)
- Voltage fault memory selectable
- Phase loss, even under phase regeneration
- Phase rotation

**Electronic voltage monitoring relays for three-phase applications**

- Multifunctional types, providing the flexibility of monitoring Undervoltage, Overvoltage, Window Mode, Phase rotation, Phase loss, Asymmetry and Neutral loss
- Phase loss monitoring, even under phase regeneration
- Positive safety logic - Make output contact opens if the relay detects an error
- All functions and values can be easily adjusted by the selector and trimmer on front face
- "Blade + cross" – both flat blade and cross head screw drivers can be used to adjust the regulators and the function selector
- Colored LEDs for clear & immediate visual indication
- 1 or 2 CO relay output, 6 or 8 A
- Modular housing, 35 mm wide
- 35 mm rail (EN 60715) mount
- Cd-free contact material

Screw terminal



For outline drawing see page 10

**Contact specification**

		70.41	70.42
Contact configuration		1 CO (SPDT)	2 CO (DPDT)
Rated current/Maximum peak current	A	6/10	8/15
Rated voltage/ Max. switching voltage	V AC	250/400	250/400
Rated load AC1	VA	1500	2000
Rated load AC15	VA	500	400
Single phase motor rating (230 V AC)	kW	0.185	0.3
Breaking capacity DC1: 30/110/220 V	A	6/0.2/0.12	8/0.3/0.12
Minimum switching load	mW (V/mA)	500 (12/10)	300 (5/5)
Standard contact material		AgNi	AgNi

**Supply specification**

		70.41	70.42
Nominal system voltage ( $U_N$ )	V AC (50/60 Hz)	380...415	380...415
Rated power	VA (50 Hz)/W	11/0.9	12.5/1
Operating range	V AC (50/60 Hz)	220...510	220...510

**Technical data**

		70.41	70.42
Electrical life at rated load AC1	cycles	$60 \cdot 10^3$	$60 \cdot 10^3$
Voltage detection level range	V	300...480	300...480
Asymmetry detection level range	%	4...25	5...25
Switch-off delay time (T on function diagrams)	s	0.5...60	0.5...60
Switch-on lock-out time	s	1	1
Switch-on hysteresis (H on function diagrams)	V	10 (L-L)	10 (L-L)
Power-on activation time	s	$\approx 1$	$\approx 1$
Insulation between supply and contacts (1.2/50 $\mu$ s)	kV	4	4
Dielectric strength between open contacts	V AC	1000	1000
Ambient temperature	$^{\circ}$ C	-20...+60	-20...+60
Protection category		IP 20	IP 20

**Approvals** (according to type)

**70.41**

Three-phase (380...415 V, with or without neutral) voltage monitoring:

- Window mode (overvoltage + undervoltage)
- Phase loss
- Phase rotation
- Asymmetry
- Neutral loss selectable

**70.42**

Three-phase (380...415 V, with neutral) voltage monitoring:

- Undervoltage
- Overvoltage
- Window mode (overvoltage + undervoltage)
- Voltage fault memory selectable
- Phase loss
- Phase rotation
- Asymmetry
- Neutral loss

**Electronic phase loss and rotation monitoring relays for three-phase applications**

- Universal voltage monitoring ( $U_N$  from 208 V to 480 V, 50/60 Hz)
- Phase loss monitoring, even under phase regeneration
- Positive safety logic - Make contact opens if the relay detects an error
- 2 versions:  
1 CO relay output, 6 A (17.5 mm wide), and  
2 CO relay output, 8 A (22.5 mm wide)
- 35 mm rail (EN 60715) mount
- European patent pending for the innovative principle at the root of the 3 phase monitoring and error survey system (70.61)

Screw terminal



For outline drawing see page 10

**Contact specification**

Contact configuration		1 CO (SPDT)	2 CO (DPDT)
Rated current/Maximum peak current	A	6/15	8/15
Rated voltage/ Max. switching voltage	V AC	250/400	250/400
Rated load AC1	VA	1500	2000
Rated load AC15	VA	250	400
Single phase motor rating (230 V AC)	kW	0.185	0.3
Breaking capacity DC1: 30/110/220 V	A	3/0.35/0.2	8/0.3/0.12
Minimum switching load	mW (V/mA)	500 (10/5)	300 (5/5)
Standard contact material		AgSnO <sub>2</sub>	AgNi

**Supply specification**

Nominal system voltage ( $U_N$ )	V AC (50/60 Hz)	208...480	208...480
Rated power	VA (50 Hz)/W	8/1	11/0.8
Operating range	V AC (50/60 Hz)	170...500	170...520

**Technical data**

Electrical life at rated load AC1	cycles	100 · 10 <sup>3</sup>	60 · 10 <sup>3</sup>
Switch-off delay time	s	0.5	0.5
Switch-on lock-out time	s	0.5	0.5
Power-on activation time	s	< 2	< 2
Insulation between supply and contacts (1.2/50 μs)	kV	5	5
Dielectric strength between open contacts	V AC	1000	1000
Ambient temperature	°C	-20...+60	-20...+60
Protection category		IP 20	IP 20

**Approvals** (according to type)



**70.61**

Three-phase (208...480)V  
voltage monitoring:

- Phase loss
- Phase rotation



**70.62**

Three-phase (208...480)V  
voltage monitoring:

- Phase loss
- Phase rotation



## Ordering information

Example: 70 series, three-phase voltage monitoring relay, 1 output, supply voltage 380...415 V AC.

70.31.8.400.2.0.2.2

### Series

### Type

- 1 = 1 phase AC line monitoring
- 3 = 3 phase AC line monitoring
- 4 = 3 phase + neutral AC line monitoring
- 6 = 3 phase loss and rotation monitoring

### No. of poles

- 1 = 1 pole
- 2 = 2 pole

### Supply version

- 8 = AC (50/60 Hz)

### Supply voltage

- 230 = 220...240 V (70.11)
- 400 = 380...415 V (70.31/41/42)
- 400 = 208...480 V (70.61/62)

### D: Fault memory option

- 0 = No fault memory
- 2 = Fault memory function selectable

### C: Time delay setting

- 0 = Fixed switch-off delay
- 2 = Adjustable switch-off delay
- 3 = Adjustable switch-off delay and asymmetry

### B: Contact circuit

- 0 = CO

### A: Detection values

- 0 = Non-adjustable detection values
- 2 = 2 adjustable detection values

### Codes

70.11.8.230.2022	70.42.8.400.2032
70.31.8.400.2022	70.61.8.400.0000
70.41.8.400.2030	70.62.8.400.0000

## Monitoring and function overview

	70.11	70.31	70.41	70.42	70.61/62
Supply system type	Single phase system	3-phase systems	3-phase systems	3-phase systems	3-phase systems
Nominal voltage 50/60 Hz	V 220...240	380...415	380...415	380...415	208...480
Undervoltage with/without memory (selectable)	•	•	—	•	—
Overvoltage with/without memory (selectable)	•	•	—	•	—
Window Mode with/without memory (selectable)	•	•	—	•	—
Window Mode without memory	—	—	•	—	—
Phase loss	—	•	•	•	•
Phase rotation	—	•	•	•	•
Phase asymmetry	—	—	•	•	—
Neutral loss (selectable)	—	—	•	• (fixed)	—

## Technical data

Insulation		70.11/31/41/42		70.61/62	
Between supply and contacts	dielectric strength	V AC	2500	3000	
	impulse (1.2/50 µs)	kV	4	5	
Between open contacts	dielectric strength	V AC	1000	1000	
	impulse (1.2/50 µs)	kV	1.5	1.5	
EMC specifications					
Type of test		Reference standard			
Electrostatic discharge	contact discharge	EN 61000-4-2		4 kV	
	air discharge	EN 61000-4-2		8 kV	
Radiated electromagnetic field	80...1000 MHz	EN 61000-4-3		10 V/m	
	1...2.8 GHz	EN 61000-4-3		5 V/m	
Fast transients (burst 5/50 ns, 5 and 100 kHz)	on supply terminals	EN 61000-4-4		4 kV	
Voltage pulses on supply terminals (surge 1.2/50 µs)	common mode	EN 61000-4-5		4 kV	
	differential mode	EN 61000-4-5		4 kV	
Radiofrequency common mode voltage (0.15...230 MHz)	on supply terminals	EN 61000-4-6		10 V	
Voltage dips	70% U <sub>N</sub>	EN 61000-4-11		25 cycles	
Short interruptions		EN 61000-4-11		1 cycle	
Radiofrequency conducted emissions	0.15...30 MHz	CISPR 11		class B	
Radiated emissions	30...1000 MHz	CISPR 11		class B	
Terminals		solid cable		stranded cable	
Max. wire size	mm <sup>2</sup>	1 x 6 / 2 x 4		1 x 4 / 2 x 2.5	
	AWG	1 x 10 / 2 x 12		1 x 12 / 2 x 14	
 Screw torque	Nm	0.8			
Wire strip length	mm	9			
Other data		70.11	70.31/41	70.42/61/62	
Power lost to the environment	without output current	W	0.8	0.9	
	with rated output current	W	2	1.2	
				1.4	

## Functions

Output relay On (NO closed) when all OK: positive logic.

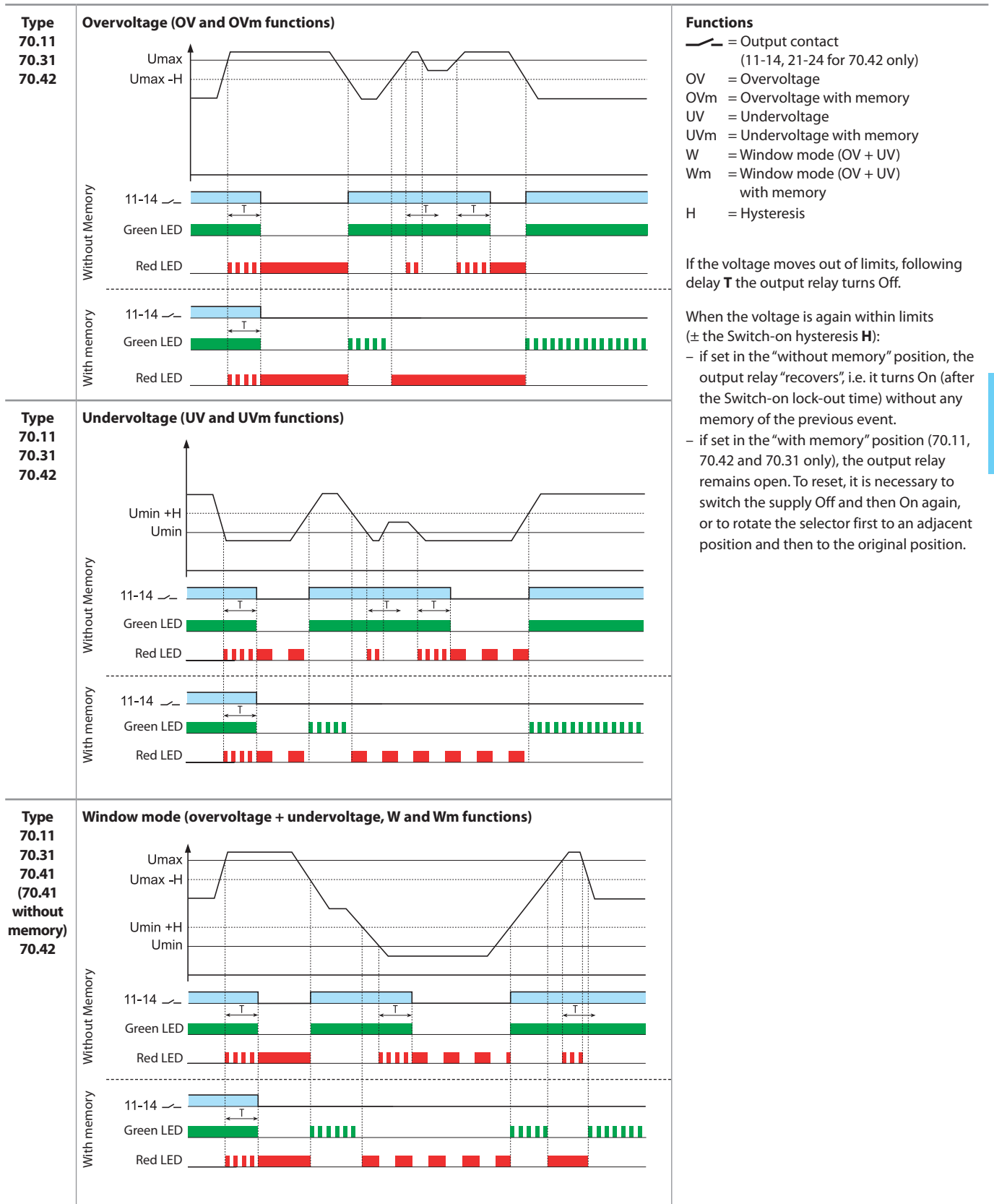

E

## Functions

Output relay On (NO closed) when all OK: positive logic.

<p><b>Type</b> 70.31 70.41 70.42 70.61 70.62</p>	<p><b>Phase loss and phase rotation</b></p>	<p>If the sequence (L1, L2, L3) is incorrect at power-on, the output relay will not turn-on.</p> <p>If a phase is lost, the output relay turns off immediately. When the phase is again active, the output relay turns on immediately.</p> <p>Phase loss monitoring possible even under regeneration up to 80% of the average of the other 2 phases.</p>
<p><b>E</b> <b>Type</b> 70.41 70.42</p>	<p><b>Neutral loss and asymmetry</b></p>	<p>If the neutral is lost (and the Neutral control function is set), the output relay turns off immediately. When the neutral is again present, the output relay turns on immediately.</p> <p>If the asymmetry <math>(U_{max} - U_{min})/U_N</math> is above the % set value, the output relay turns off after the set delay <b>T</b>. When the asymmetry is again below the % set value (with a fixed hysteresis of approximately 2%), the output relay turns on after the Switch-on lock-out time.</p>

**Front view: function selector and regulators**

<p><b>70.11</b></p> <p>Functions: OV, OVm, UV, UVm, W, Wm</p> <p>Toff delay: (0.5...60)sec</p> <p>U<sub>Max</sub>: (220...270)V</p> <p>U<sub>Min</sub>: (170...230)V</p>	<p><b>70.31</b></p> <p>Functions: OV, OVm, UV, UVm, W, Wm</p> <p>U<sub>Max</sub>: (380...480)V</p> <p>U<sub>Min</sub>: (300...400)V</p> <p>Toff delay: (0.5...60) sec</p>	<p><b>70.41</b></p> <p>N= With N-line monitoring N≠ Without N-line monitoring</p> <p>U<sub>Max</sub>: (380...480)V</p> <p>(4...25)% U<sub>N</sub></p> <p>U<sub>Min</sub>: (300...400)V</p> <p>Toff delay: (0.5...60)sec</p>
<p><b>70.42</b></p> <p>Functions: OV, OVm, UV, UVm, W, Wm</p> <p>U<sub>Max</sub>: (380...480)V</p> <p>(5...25)% U<sub>N</sub></p> <p>U<sub>Min</sub>: (300...400)V</p> <p>Toff delay: (0.5...60)sec</p>		

**E**

LED indication

Monitoring relay Type	LED	Supply system normal	Supply system abnormal (Voltage out of limits, switch-off delay time T running)	Supply system abnormal (Reason for switch-off, RESET necessary when "with Memory" is selected)
		Contact 11 - 14 closed	Contact 11 - 14 closed	Contact 11-14 open
70.11.8.230.2022	• •		 	Overvoltage OV and OVm Undervoltage UV and UVm With Memory, following a failure a manual "RESET" ** is necessary
70.31.8.400.2022	• • •		 	Overvoltage OV and OVm Undervoltage UV and UVm Phase loss Phase rotation With Memory, following a failure a manual "RESET" ** is necessary
70.41.8.400.2030	• • •		 	Overvoltage OV Undervoltage UV Asymmetry Phase loss Neutral loss Phase rotation
70.42.8.400.2032	• • •		 	Overvoltage OV and OVm Undervoltage UV and UVm Asymmetry Phase loss Neutral loss Phase rotation With Memory, following a failure a manual "RESET" ** is necessary
70.61.8.400.0000	•			Phase rotation or Phase loss
70.62.8.400.0000	•			Phase loss Phase rotation

\* The function "with Memory" is only available for type 70.11, 70.42 and 70.31.

\*\* It is necessary to switch the supply OFF and then On again (U off U on) or to rotate the function selector first to an adjacent position and then to the original position.



**Wiring diagrams**

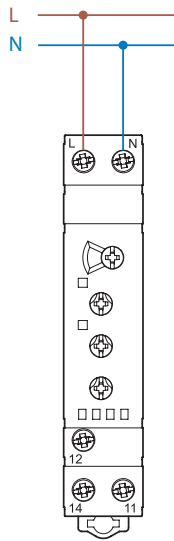

**Type 70.11**

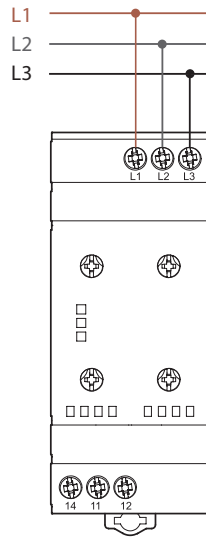

**Type 70.31**

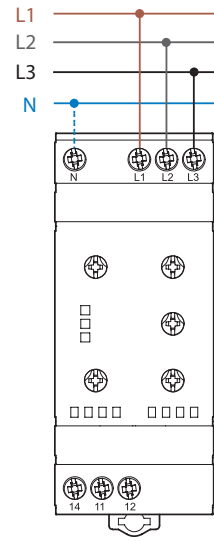

**Type 70.41**

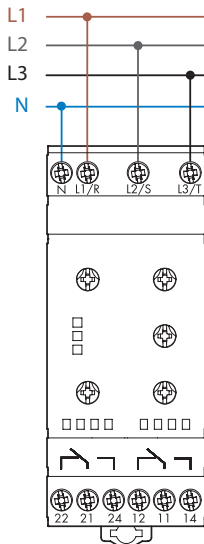

**Type 70.42**

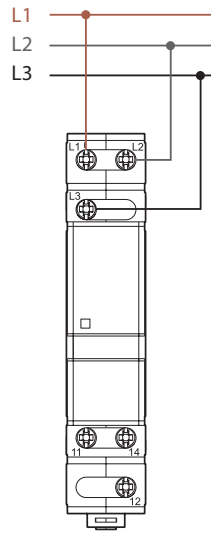

**Type 70.61**

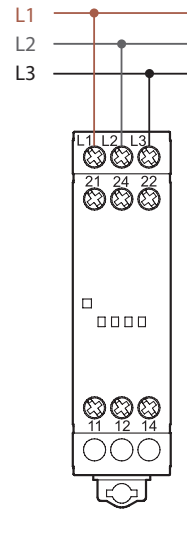

**Type 70.62**

**E**

**Application example**

The output contact switches the coil of the line contactor.

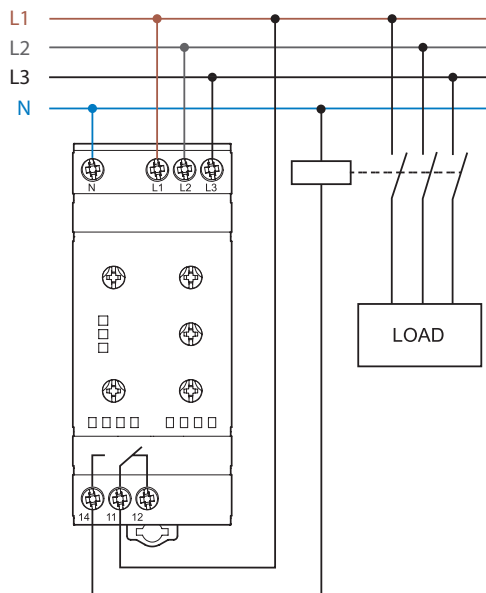

Outline drawings

70.11  
Screw terminal

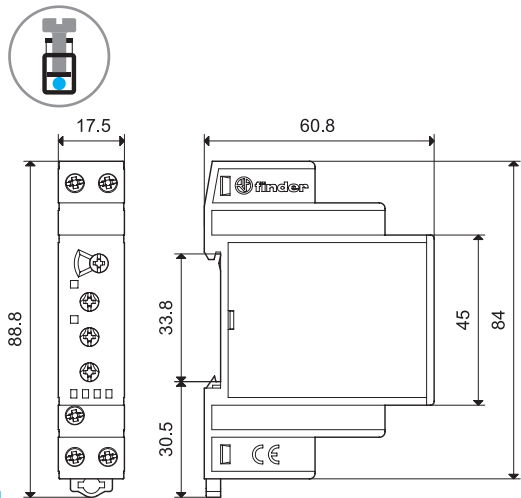

70.31  
Screw terminal

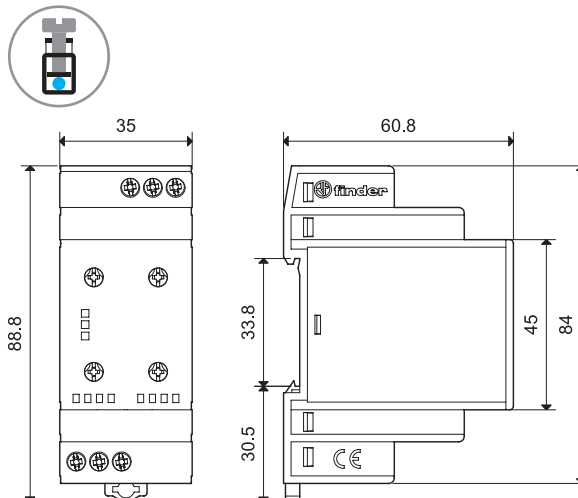

70.41  
Screw terminal

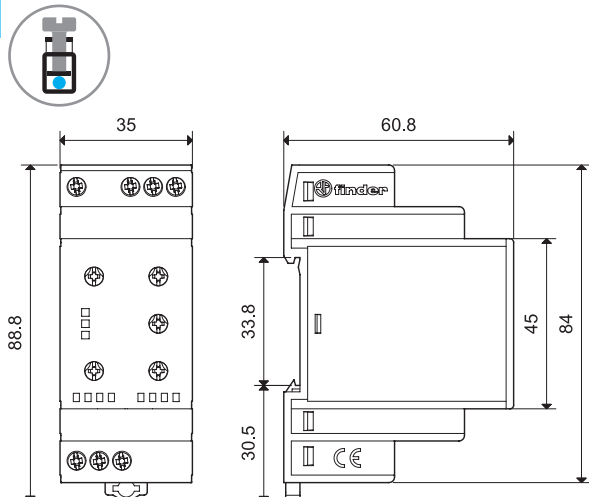

70.42  
Screw terminal

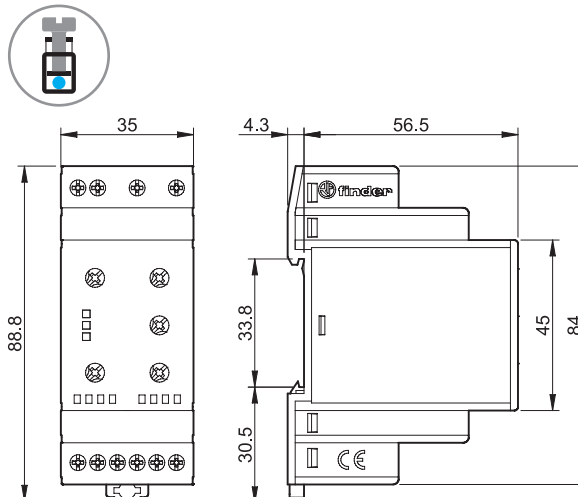

70.61  
Screw terminal

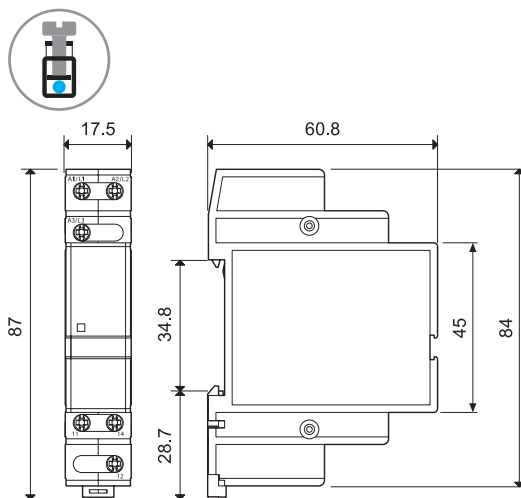

70.62  
Screw terminal

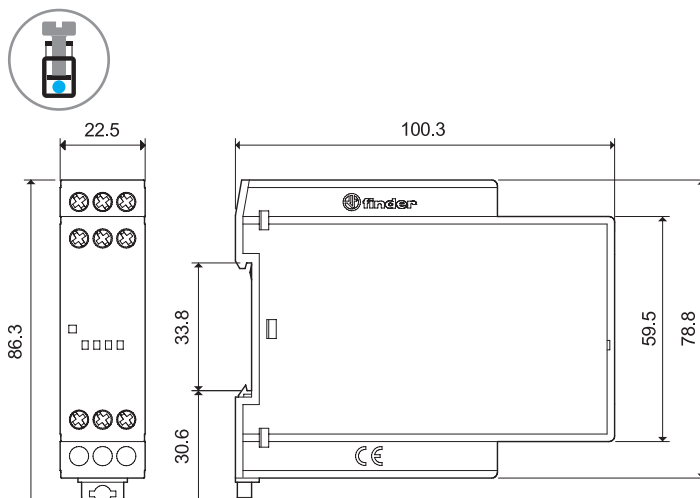

**Accessories**



**020.01**

**Adaptor for panel mounting**, plastic, 17.5 mm wide for 70.11 and 70.61

020.01

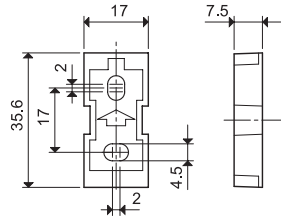

**011.01**

**Adaptor for panel mounting**, plastic, 35 mm wide for 70.31, 70.42 and 70.41

011.01

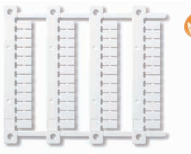
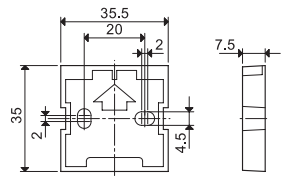

**NEW**

**060.48**

**Sheet of marker tags (CEMBRE'S Thermal transfer printers)** for relays types 70.11, 70.31, 70.41, 70.42 and 70.62 (48 tags), 6 x 12 mm

060.48

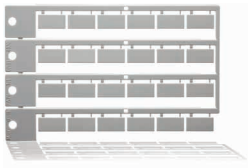

**020.24**

**Sheet of marker tags**, plastic, 24 tags, 9 x 17 mm for 70.61

020.24



**019.01**

**Identification tag**, plastic, 1 tag, 17 x 25.5 mm for 70.11, 70.31, 70.42 and 70.41

019.01

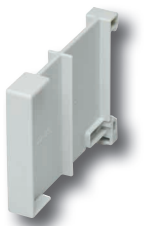

**022.09**

**Separator for rail mounting**, plastic, 9 mm wide

022.09

